



Radio / DVD / CD / MP3 / WMA

Long Beach DVD35

7 645 680 310

Operating instructions



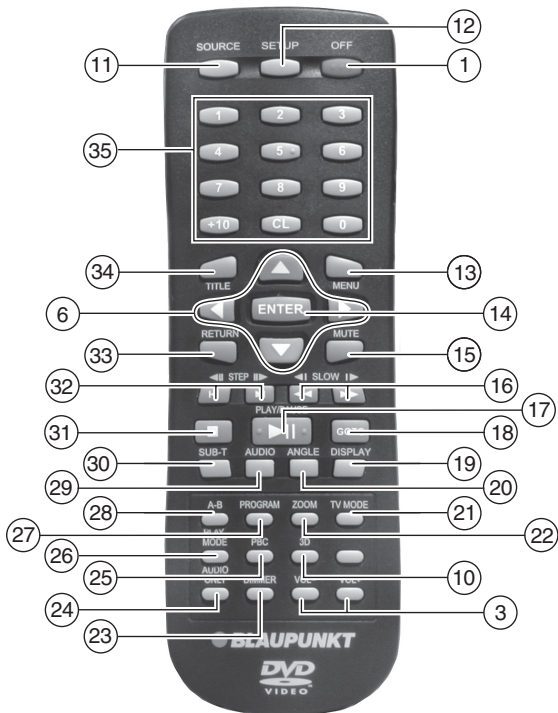

<http://www.blaupunkt.com>

 **BLAUPUNKT**



RC 14 H

- ① Button to switch the device on/off and operate the volume mute feature.
OFF button on the remote control for switching the device off.
- ②  button to open the flip-release control panel.
- ③ Volume control.
- ④ **BND•TS** button.
Short press: Selects the FM and AM memory banks.
Long press: Starts the FM/AM Travelstore function.
- ⑤ **DIS•ESC** button to change the display contents, to close the menus without saving changes.
- ⑥ Arrow buttons on the remote control and the device with identical function.
- ⑦ **MENU•OK** button
Short press: Calls up the menus for basic settings and confirms menu entries. Confirms menu entries in DVD menus.
Long press: Starts the scan function.
- ⑧ **DEQ** button to call up the equalizer menu.
- ⑨ Buttons **1 - 6**.
- ⑩ **AUDIO** button.
Adjusts bass, treble, balance, fader and X-bass.
- ⑪ **SRC** button to switch sources between CD/DVD, Tuner, CD changer (if connected) and AUX.
- ⑫ **SETUP** button to call up the setup menu of the DVD player.
- ⑬ **MENU** button to call up the main menu (root menu) of a DVD.
- ⑭ **ENTER** button to confirm menu entries on DVDs and in the setup menu.
- ⑮ **MUTE** button to mute the device.
- ⑯  buttons to start the fast forward/reverse search, to control slow-motion in DVD mode.
- ⑰  button to start and interrupt (freeze frame) the DVD playback.
- ⑱ **GOTO** button for direct selection of playing time or title on a CD/DVD, selecting playing time, chapter or title on a DVD.

CONTROLS

- 19 **DISPLAY** button to display playing time information on the external display.
 - 20 **ANGLE** button to select a camera perspective (dependent upon the DVD).
 - 21 **TV MODE** button to switch the TV standard of the DVD player to adjust to the external display.
 - 22 **ZOOM** button to zoom the image area in/out.
 - 23 **DIMMER** button to directly call up the display menu.
 - 24 **AUDIO ONLY** button
No function
 - 25 **PBC** button, playback control.
 - 26 **PLAY MODE** button for setting the repeat mode (REPEAT) of a CD or DVD.
 - 27 **PROGRAM** button to program the playlist of a CD or DVD.
 - 28 **A-B** button to define and repeat a self-defined title of a DVD/CD.
 - 29 **AUDIO** button to select the audio track of a DVD.
 - 30 **SUB-T** button to select the subtitles of a DVD.
 - 31 **STOP** button to interrupt the playback.
 - 32 **◀▶** button for up and down track selection in CD mode and to select the previous or next chapter in DVD mode, single-frame search in DVD mode.
 - 33 **RETURN** button to change back one level in the menu of a DVD.
 - 34 **TITLE** button to call up the title menu of a DVD.
 - 35 Numeric keys for direct selection of chapters and playing time in DVD mode or MP3 mode.
- ▲ button to eject the DVD/CD from the device (visible only with opened control panel).

Notes and accessories	8	Listening to stored stations	18
Road safety	8	Scanning receivable stations (SCAN)	18
Installation	8	Setting the scanning time	18
Remote control RC 14 H	8	Programme type (PTY)	18
Installations (not part of the scope of delivery) ..	9	Optimising radio reception	20
Activating/deactivating demo mode ..	9	SHARX	20
Time-out (time window)	9	Configuring the display	21
Detachable control panel	10	DVD operation	21
Theft protection	10	Region code	21
Detaching the control panel	10	License	22
Attaching the control panel	11	Switching to DVD mode	22
Switching on/off	11	Starting playback	23
Adjusting the volume	12	Display	23
Setting the power-on volume	12	Fast forward/reverse search	23
Quickly reducing the volume (Mute)	13	Slow motion	24
Telephone audio/navigation audio ..	13	Single frame	24
Setting the volume of the confirmation beep	14	Freeze frame	24
Automatic sound	15	Interrupting playback	24
Radio mode	15	Skipping a chapter	25
Adjusting the tuner	15	Repeated playback of a DVD title ..	25
Switching to radio mode	16	Direct selection of a chapter	25
Switching the RDS function on or off (FM only)	16	Resuming playback at the start of the first title of a DVD	26
Selecting the waveband/ memory bank	16	Displaying subtitles	26
Tuning into a station	16	Selecting the playback language ..	27
Setting the sensitivity of station seek tuning	17	Changing the camera perspective ..	27
Storing stations	17	Zooming in/out of an image area ..	27
Storing stations automatically (Travelstore)	17		

CONTENTS

DVD menu	28	CD mode	37
Displaying the DVD menu	28	Switching to CD mode	37
Selecting menu entries	28	Selecting tracks	37
Exiting the DVD menu	28	Direct track selection with the	
Displaying the title menu	28	remote control	37
Playback of DVD audio	29	Fast track selection	38
Repeated playback of a defined		Fast searching (audible)	38
section of a title	29	Random track play (MIX)	39
Programming your favourite track		Scanning tracks (SCAN)	39
with the remote control	29	Repeating tracks (REPEAT)	39
DVD setup	30	Repeated playback of a defined	
Calling up the setup menu	30	section of a title	40
Performing settings in the		Interrupting playback (PAUSE)	40
setup menu	30	Changing the display	40
General Setup - general settings ..	31	Displaying CD text	41
Audio Setup	32	Programming your favourite track	
Video Setup - image settings	32	with the remote control	41
Preferences - preferred settings ..	33	Ejecting a CD	42
Setting password protection -		MP3/WMA mode	42
Assigning a password	35	Preparing an MP3/WMA CD	42
Exiting the setup menu	36	Switching to MP3 mode	44
		Setting the display	
		(internal display)	44
		Selecting the directory	
		on the device	44
		Selecting a track on the device ...	45
		Selecting a directory/track	
		with the remote control	45
		Fast search	46
		Random track play – MIX	47
		Scanning tracks – SCAN	47
		Repeated playback of individual tracks	
		or entire directories – REPEAT	47
		Repeated playback of a defined	
		section of a title	48
		Interrupting playback (PAUSE)	48
		Selecting MP3 info	48
		Displaying scrolling texts (scroll) ..	49

CD-changer mode	49	Sound	54
Switching to CD-changer mode ...	49	Adjusting the bass	54
Selecting CDs	49	Adjusting the treble	54
Selecting tracks	49	Setting the left/right volume distribution (balance)	55
Fast searching (audible)	50	Adjusting the front/rear volume distribution (fader)	55
Changing the display	50	X-BASS	55
Repeating individual tracks or whole CDs (REPEAT)	50	Equalizer	56
Random track play (MIX)	51	Switching the equalizer on/off	56
Scanning all tracks on all CDs (SCAN)	51	Selecting sound presets	56
Naming CDs	51	Selecting vehicle presets	57
CLOCK time	53	Manually adjusting the equalizer ...	57
Displaying the time	53	Help adjusting the equalizer	59
Setting the clock manually	53	Adjusting the display settings .	60
Selecting 12/24-hour clock mode ..	53	Adjusting the display brightness...	60
Displaying the time continuously when the device is off and the ignition is on	53	Adjusting the viewing angle	60
		External audio sources	61
		Switching the AUX input on/off ...	61
		Amplifier/sub-out	62
		Switching the internal amplifier on/off	62
		Switching the dual zone on/off	62
		Specifications	63
		Amplifier	63
		Tuner	63
		DVD	63
		CD	63
		Pre-amp out	63
		Input sensitivity	63

Notes and accessories

Thank you for choosing a Blaupunkt product. We hope you enjoy using this new piece of equipment.

Please read these operating instructions before using the equipment for the first time.

The Blaupunkt editors are constantly working on making the operating instructions clearer and easier to understand. However, if you still have any questions on how to operate the device, please contact your dealer or the telephone hotline for your country. You will find the telephone number printed at the back of this booklet.

We provide a manufacturer guarantee for our products bought within the European Union. You can view the guarantee conditions at www.blaupunkt.de or ask for them directly at:

Blaupunkt GmbH
Hotline
Robert Bosch Str. 200
D-31139 Hildesheim

Road safety

 Road safety has absolute priority. Only operate your car sound system if the road and traffic conditions allow you to do so. Familiarise yourself with the device before setting off on your journey. You should always be able to hear police, fire and ambulance sirens in good time from inside your vehicle. For this reason, listen to your car sound system at a suitable volume level during your journey.

Note that due to road safety, the driver should be viewing videos only while the vehicle is standing.

Installation

If you want to install your car sound system yourself, please read the installation and connection instructions that follow these operating instructions.

Remote control RC 14 H

When you operate the Long Beach DVD35 for the first time, you must insert the batteries in the remote control.

Inserting the batteries

1. Open the battery compartment by removing the cover.
2. Battery size: Two AAA batteries, type LR03 Micro.
Before inserting the batteries, ensure that the poles of the battery are aligned as shown in the battery compartment.
Insert the batteries.
3. Close the battery compartment.

Note:

Exhausted batteries do not belong in household waste; they should be disposed of according to local regulations.

Activating the remote control

Point the remote control at the infrared receiver in the front of the device.

Operating angle: Approx. 30° in each direction from the front side of the IR receiver in the front of the device.

The accompanying remote control allows for operating all the functions of the DVD mode and controlling the basic functions of the other operating modes.

You cannot switch the device on/off using the accompanying remote control.

Installations

(not part of the scope of delivery)

Use only accessories approved by Blaupunkt.

● Remote controls

The RC 10 steering wheel remote control allows you to access the most important functions of your car sound system safely and conveniently from your steering wheel.

You cannot switch the device on/off using the remote control.

The RC 13 H cable remote control and the corresponding adapter allows for controlling the RSA (Rear Seat Entertainment) in the dual zone mode. You can obtain further information from your Blaupunkt dealer.

● External display

An external display is required to view DVD movies and VCDs. You can obtain further information about suitable monitors from your Blaupunkt dealer.

● Amplifiers

Any Blaupunkt amplifier can be used.

● CD changers

You can connect the following Blaupunkt CD changers:
CDC A 03, CDC A 08 and
IDC A 09.

Activating/deactivating demo mode

You can activate the demo mode at the device. In demo mode, the different functions of the device are displayed.

⇨ Press the **MENU•OK** button (7).

The display shows the menu.

⇨ Press and hold the **MENU•OK** button (7) pressed for more than four seconds while the menu is displayed to activate or deactivate the demo mode.

Time-out (time window)

The device features a time-out function.

For example, if you press the **MENU•OK** button (7) and select a menu item, the device switches back after approx. 16 seconds after the last button activation. The settings performed are saved.

CONTROL PANEL

Detachable control panel

Theft protection

The device is equipped with a detachable control panel (flip-release panel) as a way of protecting your equipment against theft. The device is worthless to a thief without this control panel.

Protect your device against theft by taking the control panel with you whenever you leave your vehicle. Do not leave the control panel inside your vehicle - not even in a hiding place.

The control panel has been designed to be easy to use.

Notes:

- Never drop the control panel.
- Never expose the control panel to direct sunlight or other heat sources.
- Avoid direct skin contact with the control panel's electrical contacts. If necessary, please clean the contacts of the KeyCard with a lint-free cloth moistened with cleaning alcohol.

Detaching the control panel

- ⇨ Press the  button (2).

The control panel opens out towards you.

- ⇨ Hold the control panel by its right side and then pull it straight out of the bracket.

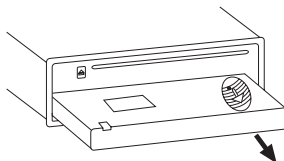

Notes:

- All the current settings are saved.
- Any inserted DVD/CD remains in the device.
- The device switches off automatically after approx. one minute.

Attaching the control panel

- ⇨ Hold the control panel at approximately right angles to the device.
- ⇨ Slide the control panel into the device's guides that are positioned on the left and right at the lower edge of the housing. Push the control panel carefully into the bracket until it clicks into place.
- ⇨ Flip up the control panel and carefully press it into the device until it clicks into place.

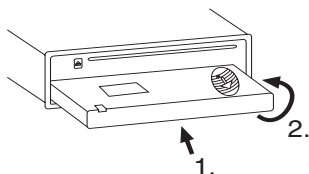
**Note:**

When attaching the control panel, make sure you do not press the display.

If the device was still switched on when you detached the control panel, it will automatically switch on with the last setting activated (radio, DVD/CD, CD changer or AUX) when the panel is replaced.

Switching on/off

There are various ways of switching the device on/off:

Switching on/off using the vehicle ignition

The device will switch on/off simultaneously with the ignition if the device is correctly connected to the vehicle's ignition and you did not switch the device off by pressing button ①.

Switching the device on/off using the detachable control panel

- ⇨ Detach the control panel.

The device switches off automatically after approx. one minute.

- ⇨ Attach the control panel again.

The device switches on. The last setting (radio, DVD/CD, CD changer or AUX) will be reactivated.

Switching on/off using button ①

- ⇨ To switch on the device, press button ①.
- ⇨ To switch off the device, press and hold down button ① for longer than two seconds.

The device switches off.

Note:

To protect the vehicle battery, the device will switch off automatically after one hour if the ignition is off.

Switching the device off with the remote control

The device can also be switched off using the supplied RC 14 H remote control.

- ⇒ Press the **OFF** button (1) on the remote control.

The device switches off.

Adjusting the volume

Note:

The internal amplifier can be switched off. If the loudspeakers do not emit any sound, please read the section entitled “Switching the internal amplifier on/off” in the “Amplifier” chapter.

You can adjust the volume in steps from 0 (off) to 50 (maximum).

To increase the volume,

- ⇒ turn the volume control (3) clockwise.

To decrease the volume,

- ⇒ turn the volume control (3) anti-clockwise.

Adjusting the volume with the remote control

The volume can also be adjusted using the supplied remote control.

- ⇒ To increase the volume, press the **VOL+** button (3) on the remote control.
- ⇒ To decrease the volume, press the **VOL-** button (3) on the remote control.

Setting the power-on volume

You can set the default volume level at which the device plays when it is switched on.

- ⇒ Press the **MENU•OK** button (7).
- ⇒ Press the **V** or **Λ** button (6) repeatedly until “VOLUME MENU” appears on the display.

- ⇨ Press the **MENU•OK** button (7) to display the volume menu.

“ON VOLUME” and the currently set value are displayed or “LAST VOLUME” is displayed.

- ⇨ Adjust the power-on volume using the **<>** buttons (6).

To help you adjust the setting more easily, the device will increase or decrease the volume as you make your changes.

If you change the setting to “LAST VOLUME”, the volume when the device switches on will be the same as the volume level that was set the last time you switched the device off.

Danger to hearing!

If the power-on volume is set to maximum, the volume level can be very high when the device is switched on.

If the volume was set to maximum before the device was switched off and the power-on volume is set to “LAST VOLUME”, the volume level can be very high when the device is switched on again.

Severe damage to your hearing can be caused in both cases!

When you have finished making your changes,

- ⇨ press the **MENU•OK** button (7) and then the **DIS•ESC** button (5) to exit the menu.

Quickly reducing the volume (Mute)

You can quickly reduce the volume to a preset level (Mute).

- ⇨ **Briefly** press button (1).

“MUTE” appears on the display.

Cancelling mute

To return to your previously set volume level,

- ⇨ **briefly** press button (1) again.

Muting with the remote control

The volume can also be muted using the supplied remote control.

- ⇨ Press the **MUTE** button (15) on the remote control.

“MUTE” appears on the display.

Cancelling mute

To return to your previously set volume level,

- ⇨ press the **MUTE** button (15) again.

Telephone audio/navigation audio

If your car sound system is connected to a mobile telephone or a navigation system, the sound system’s volume will be muted as soon as you “pick up” the phone or as soon as a navigation announcement is made. You will then hear the caller or navigation announcement over the car sound system’s loudspeakers. In order for this feature to work, the mobile telephone or navigation system must be connected to the car sound system as described in the installation instructions.

ADJUSTING THE VOLUME

You will need a cable for this with the following Blaupunkt number: 7 607 001 503.

You can find out from your Blaupunkt dealer which navigation systems can be used with your car sound system.

The volume with which telephone calls or navigation announcements are broadcast can be adjusted.

- ⇒ Press the **MENU•OK** button (7).
- ⇒ Press the **V** or **Λ** button (6) repeatedly until "VOLUME MENU" appears on the display.
- ⇒ Press the **MENU•OK** button (7) to display the volume menu.
- ⇒ Press the **V** or **Λ** button (6) repeatedly until "TEL/NAVI" appears on the display.
- ⇒ Set your preferred volume level using the **<>** buttons (6).

When you have finished making your changes,

- ⇒ press the **MENU•OK** button (7) and then the **DIS•ESC** button (5) to exit the menu.

Note:

You can use the volume control (3) to adjust the volume of telephone calls and navigation announcements whilst you are listening to them.

Setting the volume of the confirmation beep

The system will output a confirmation beep for some functions if you keep a button pressed down for longer than approx. two seconds, for instance, when assigning a radio station to a station preset button. You can adjust the volume of this beep.

- ⇒ Press the **MENU•OK** button (7).
- ⇒ Press the **V** or **Λ** button (6) repeatedly until "VOLUME MENU" appears on the display.
- ⇒ Press the **MENU•OK** button (7) to display the volume menu.
- ⇒ Press the **V** or **Λ** button (6) repeatedly until "BEEP VOL" appears on the display.
- ⇒ Adjust the volume using the **<>** buttons (6). "0" means that the beep is deactivated, "6" means that the maximum beep volume is set.

When you have finished making your changes,

- ⇒ press the **MENU•OK** button (7) and then the **DIS•ESC** button (5) to exit the menu.

Automatic sound

This feature automatically adjusts the volume of the car sound system to suit the speed at which the vehicle is travelling. In order for this to work, your car sound system must be connected as described in the installation instructions.

You can adjust the automatic volume boost feature in six steps from (0 to 5).

- ⇨ Press the **MENU•OK** button (7).
- ⇨ Press the **V** or **▲** button (6) repeatedly until "VOLUME MENU" appears on the display.
- ⇨ Press the **MENU•OK** button (7) to display the volume menu.
- ⇨ Press the **V** or **▲** button (6) repeatedly until "AUTO SOUND" appears on the display.
- ⇨ Set the volume adjustment level using the **<>** buttons (6).

When you have finished making your changes,

- ⇨ press the **MENU•OK** button (7) and then the **DIS•ESC** button (5) to exit the menu.

Note:

The optimum setting for the speed-dependent volume adjustment feature depends on how noise levels develop in your particular vehicle. You will need to test various settings in order to find out which is best suited to your vehicle.

Radio mode

This device is equipped with an RDS radio receiver. Many of the receivable FM stations broadcast a signal that not only carries the programme but also additional information such as the station name and programme type (PTY). The station name appears on the display as soon as the tuner receives it.

Adjusting the tuner

To ensure proper functioning of the tuner, the device must be set for the region in which you are located. You can select among USA, South America (S-America), Asia (ASIA), Europe (EUROPE) and Thailand. The device is factory-set to the region in which it was delivered. If you experience problems with your radio reception, please check this setting.

These operating instructions apply to the regional setting for USA, South America, Asia and Thailand.

- ⇨ Switch off the device by pressing button (1).
- ⇨ Press the buttons **3** and **6** (9) and hold them pressed.
- ⇨ Press and hold the button (1) until the display shows TUNER AREA.

The currently set region is shown on the upper display line.

- ⇨ To select the region, press the **>** or **<** button (6).
- ⇨ Press the **MENU•OK** button (7) to exit the menu and save the setting.

RADIO MODE

Switching to radio mode

To start the radio mode,

- ⇒ press the **BND•TS** button (4)
- or
- ⇒ press the **SRC** button (11) on the device or the **SOURCE** button (11) on the remote control repeatedly until “TUNER” appears on the display.

Switching the RDS function on or off (FM only)

The RDS function expands the performance spectrum of your tuner.

If the RDS function is activated, the radio automatically tunes into the best receivable frequency for the station that is currently set.

To use the RDS function,

- ⇒ press the **MENU•OK** button (7).
- “TUNER MENU” appears on the display.
- ⇒ Press the **MENU•OK** button (7) to display the tuner menu.
- “RDS ON” or “RDS OFF” appears on the display.
- ⇒ To switch RDS on/off, press the > or < button (6).
- ⇒ Press the **MENU•OK** button (7) and then the **DIS•ESC** button (5) to exit the menu.

The RDS functions are active if RDS appears on the display.

Selecting the waveband/ memory bank

This device can be used to receive stations in the FM and AM frequency bands. Three memory banks (FM1, FM2 and FMT) are available for the FM waveband and two memory banks (AM and AMT) for the AM waveband.

Six stations can be stored in each memory bank.

To switch between the memory banks FM1, FM2 and FMT or the memory banks AM and AMT,

- ⇒ briefly press the **BND•TS** button (4).

Tuning into a station

There are various ways of tuning into a station.

Automatic station seek tuning

- ⇒ Press the **V** or **^** button (6).

The radio tunes into the next receivable station.

Tuning into stations manually

You can also tune into stations manually.

Note:

You can only tune into stations manually if the RDS function is deactivated.

- ⇒ Press the < or > button (6).

Setting the sensitivity of station seek tuning

You can choose whether the radio should only tune into stations providing good reception or whether it can also tune into those with a weak reception.

- ⇨ Press the **MENU•OK** button (7).
“TUNER MENU” appears on the display.
- ⇨ Press the **MENU•OK** button (7) to display the tuner menu.
- ⇨ Press the **V** or **^** button (6) repeatedly until “SENS” appears on the display.

The display shows the currently set sensitivity level. “SENS HI3” means that the tuner is set to the highest sensitivity setting. “SENS LO1” means it is set to the lowest sensitivity setting.

- ⇨ Set the sensitivity level that you want using the **<>** buttons (6).

When you have finished making your changes,

- ⇨ press the **MENU•OK** button (7) and then the **DIS•ESC** button (5) to exit the menu.

Note:

You can adjust different sensitivities for FM and AM.

Storing stations

Storing stations manually

- ⇨ Select the desired memory bank FM1, FM2, FMT, AM or AMT.
- ⇨ Tune into the station that you want.
- ⇨ Press and hold down one of the station buttons **1 - 6** (9) for longer than two seconds to assign the station to that button.

Storing stations automatically (Travelstore)

You can automatically store the six strongest stations in the region. The stations are stored in the FMT or AMT memory bank.

Note:

Any stations that were previously stored in this memory bank are deleted in the process.

- ⇨ First, select an FM memory bank for an FM Travelstore or an AM memory bank for an AM Travelstore.
- ⇨ Press and hold down the **BND•TS** button (4) for longer than two seconds.

The storing procedure begins. “TRAVEL STORE PLEASE WAIT” appears on the display. After the process has completed, the radio will play the station that is stored in memory location 1 of the FMT or AMT memory bank.

RADIO MODE

Listening to stored stations

- ⇨ Select the memory bank or wave-band.
- ⇨ Press the station button **1 - 6** (9) of the desired station.

Scanning receivable stations (SCAN)

You can use the scan function to play all the receivable stations briefly. You can set the scanning time from 5 to 30 seconds in the menu in increments of five seconds.

Starting SCAN

- ⇨ Press and hold down the **MENU•OK** button (7) for longer than two seconds.

Scanning begins. "SCAN" appears briefly on the display followed by a display of the current station name or frequency.

Cancelling SCAN and continuing listening to a station

- ⇨ Press the **MENU•OK** button (7).

Scanning stops and the radio continues playing the station that it tuned into last.

Setting the scanning time

- ⇨ Press the **MENU•OK** button (7). "TUNER MENU" appears on the display.
- ⇨ Press the **V** or **Λ** button (6) repeatedly until "VARIOUS MENU" appears on the display.

- ⇨ Press the **MENU•OK** button (7) to display the menu. "SCAN TIME" and the currently set time are displayed.
- ⇨ Set the scanning time that you want using the **<>** buttons (6).

When you have finished making your changes,

- ⇨ press the **MENU•OK** button (7) and then the **DIS•ESC** button (5) to exit the menu.

Note:

The defined scanning time is also applied by the system to scanning carried out in DVD/CD and CD-changer mode.

Programme type (PTY)

Besides transmitting the station name, some FM stations also provide information on the type of programme that they are broadcasting. Your car radio can receive and display this information.

For example, the programme types can be:

CULTURE	TRAVEL	JAZZ
SPORT	NEWS	POP
ROCK	CLASSICS	

You can use the PTY function to select stations of a particular programme type.

PTY-EON

If you specify the programme type and start seek tuning, the radio will switch from the current station to a station of the selected programme type.

Notes:

- If the tuner does not find a station that corresponds to the selected programme type, you will hear a beep and “NO PTY” appears briefly on the display. The radio will then retune to the station that it received last.
- If the tuned radio station or another station on the broadcasting network broadcasts your selected programme type at a later point in time, the radio will automatically switch from the currently tuned station or from DVD/CD or CD-changer mode to the station whose programme type matches the one you selected.

Switching PTY on/off

- ⇨ Press the **MENU•OK** button (7). “TUNER MENU” appears on the display.
- ⇨ Press the **MENU•OK** button (7) to display the tuner menu.
- ⇨ Press the **V** or **^** button (6) repeatedly until “PTY” appears on the display with the current setting.
- ⇨ Press the **>** or **<** button (6) to switch PTY ON or OFF.
- ⇨ Press the **MENU•OK** button (7) and then the **DIS•ESC** button (5) to exit the menu.

Selecting a programme type and starting seek tuning

- ⇨ Press the **<** or **>** button (6).

The programme type that you selected last appears on the display.

- ⇨ If you want to select another programme type, you can do so by pressing the **<** or **>** button (6) whilst this display is visible.

Or

- ⇨ Press one of the buttons **1 - 6** (9) to select a programme type that is assigned to one of these buttons.

The selected programme type appears briefly on the display.

- ⇨ Press the **V** or **^** button (6) to start seek tuning.

The radio will then tune into the next station that it finds that corresponds to your selected programme type.

Assigning a programme type to a station button

- ⇨ Select a programme type using the **<** or **>** button (6).
- ⇨ Press and hold the desired station button **1 - 6** (9) for longer than two seconds.

The programme type is stored on the selected button **1 - 6** (9).

RADIO MODE

Optimising radio reception

Treble reduction feature during interference (HICUT)

The HICUT function improves reception during poor radio reception (only FM). If reception interferences are present, the interference level is automatically reduced.

Switching HICUT on/off

- ⇨ Press the **MENU•OK** button (7).
“TUNER MENU” appears on the display.
- ⇨ Press the **MENU•OK** button (7) to display the tuner menu.
- ⇨ Press the **V** or **Λ** button (6) repeatedly until “HICUT” appears on the display.
- ⇨ Press the **<** or **>** button (6) to adjust the HICUT setting.

“HICUT 0” means that no automatic reduction of the interference level will be made; “HICUT 2” means that a maximum reduction will be made.

- ⇨ Press the **MENU•OK** button (7) and then the **DIS•ESC** button (5) to exit the menu.

SHARX

The SHARX function allows you to largely avoid interference caused by neighbouring radio stations (FM only). Switch on the SHARX function if the density of radio stations in your area is very high.

Switching SHARX on/off

- ⇨ Press the **MENU•OK** button (7).
“TUNER MENU” appears on the display.
- ⇨ Press the **MENU•OK** button (7) to display the tuner menu.
- ⇨ Press the **V** or **Λ** button (6) repeatedly until “SHARX” appears on the display.
- ⇨ Press the **<** or **>** button (6) to switch SHARX on/off.

“SHARX OFF” means automatic bandwidth switching is deactivated, “SHARX ON” means it is activated.

- ⇨ Press the **MENU•OK** button (7) and then the **DIS•ESC** button (5) to exit the menu.

Configuring the display

In radio mode, you can choose between various display modes.

1. "NORMAL MODE"

First line: Memory bank and station name (if it can be received)
Second line: Frequency of the selected station.

2. "CLOCK MODE"

First line: Memory bank and station name (if it can be received)
Second line: frequency of the selected station and clock time.

3. "MINIMAL MODE"

First line: Memory bank and station name (if it can be received)
Second line: No display.

- ⇨ Briefly press the **DIS•ESC** button  to switch between the options.

DVD operation

 Risk of severe damage to the DVD/CD drive!

Mini DVDs/CD singles with a diameter of 8 cm and non-circular contoured DVDs/CDs (shape CDs) must not be used.

We accept no responsibility for any damage to the DVD/CD drive that may occur as a result of the use of unsuitable DVDs/CDs.

Region code

Code	Region
1	North America, incl. the US and Canada.
2	Japan, Europe (excl. Eastern Europe), Middle East, South Africa.
3	Korea and South-East Asia.
4	Oceania incl. Australia, New Zealand, Central and South America.
5	India, Eastern Europe, Africa, and Russia.
6	China.
All	regions.

The DVDs are identified with the region code applicable to the respective region.

This device is permanently set to the region code that is valid for the region in which it was sold.

If the device does not play a DVD ("WRONG RC" is shown on the internal display), please check whether the DVD features the region code that is valid for your region.

DVD OPERATION

Playing a DVD with a different region code is not possible.

This device can be used to play the following data carriers/data formats:

- DVD video and DVD audio.
DVD-MP3/WMA.
- Video CD (VCD).
- MP3/WMA CDs, see the chapter “MP3/WMA mode”.
- Audio CDs, see the chapter “CD mode”.

License

Manufactured under license of Dolby Laboratories. “Dolby”, “Pro Logic” and the double-D symbol are trademarks of Dolby Laboratories.

This product contains technologies that are copyright-protected under certain US-American patents. The copyrights are property of Macrovision Corporation and other copyright owners. The use of this copyright-protected technology must be approved by Macrovision Corporation and is intended exclusively for private use and other presentations in a limited scope, unless Macrovision Corporation first issued a respective permission.

Switching to DVD mode

If there is no DVD inserted in the drive,

- ⇨ switch on the device by pressing button ①.
- ⇨ Press the  button ②.

The control panel opens.

- ⇨ Gently insert the DVD with its printed side pointing up into the drive until you feel some resistance.

The drive draws in the DVD automatically.

You must not hinder or assist the drive as it draws in the DVD.

- ⇨ Gently close the control panel whilst exerting a little pressure until you feel it click into place.

The DVD data are loaded.

Dependent upon the inserted DVD, the playback starts or the DVD menu displays.

If a DVD is already inserted in the drive,

- ⇨ press the **SRC** button ⑪ on the device or the **SOURCE** button ⑪ on the remote control repeatedly until “DVD” appears on the display.

Playback begins from the point at which it was last interrupted.

Starting playback

After the desired DVD/VCD is loaded, either the DVD menu is displayed or the playback starts. This action is dependent upon the inserted DVD.

- ⇨ Press the **▶▶** button (17) or move the selection mark to the menu item that starts the movie, and press the **ENTER** button (14) to start the playback.

The DVD starts playing.

Display

Different information about the playing time can be shown on the connected display. The display can be hidden.

The following displays are available:

- **TITLE ELAPSED**

Example: **TITLE 01/12 CHAPTER 08/26 01 : 26 : 14**: The first of twelve titles and the eighth of 26 chapters of this title is playing. Next to it is the time elapsed of the current title.

- **TITLE REMAIN**

Example: **TITLE 01/12 CHAPTER 08/26 00 : 31 : 58**: The first of twelve titles and the eighth of 26 chapters of this title is playing. Next to it is the time remaining of the current title.

- **CHAPTER ELAPSED**

Example: **TITLE 01/12 CHAPTER 08/26 00 : 01 : 34**: The first of twelve titles and the eighth of 26 chapters of this title is playing. Next to it is the elapsed playing time of the current chapter.

- **CHAPTER REMAIN**

Example: **TITLE 01/12 CHAPTER 08/26 00 : 05 : 22**: The first of twelve titles and the eighth of 26 chapters of this title is playing. Next to it is the remaining playing time of the current chapter.

Showing/changing the display information

- ⇨ Press the **DISPLAY** button (19) on the remote control repeatedly until the desired information is displayed.

The display information is shown at the top edge of the display.

Hiding the display information

- ⇨ Press the **DISPLAY** button (19) repeatedly until **DISPLAY OFF** displays briefly and the display information is hidden.

Fast forward/reverse search

You can fast forward or reverse the DVD at 2x, 4x, 8x, 16x and 32x the speed (dependent upon the DVD; some DVDs can only be played up to 16x the speed).

To fast forward or reverse search the DVD,

- ⇨ press the **▶▶** or **◀◀** button (16) on the remote control repeatedly until the desired speed is displayed.

DVD OPERATION

Stopping fast forward/reverse search

To stop fast forward,

- ⇨ press the **▶▶** button (17) on the remote control.

The DVD is played back at normal speed.

Slow motion

The DVD can be played forward or reverse at reduced speed.

- ⇨ First, press the **▶▶** button (17) on the remote control.

- ⇨ Press the **SLOW ▶** button (16) once or several times on the remote control for forward slow motion

or

- ⇨ the **SLOW ◀** button (16) for reverse slow motion.

After pressing the **SLOW ◀ / ▶** button (16) several times, the playback is switched to half the regular speed (1/2).

With every additional press of the button, the speed is reduced further (1/4, 1/8 and 1/16).

To play the DVD at regular speed again,

- ⇨ press the **▶▶** button (17) on the remote control.

Single frame

You can stop the movie of a DVD and watch it in single frames.

- ⇨ First, press the **▶▶** button (17) on the remote control.

- ⇨ Press the **STEP ▶▶** button (32) on the remote control once or several times to display the next frames

or

- ⇨ press the **STEP ◀◀** button (32) to display the previous frames.

Freeze frame

- ⇨ During playback, press the **▶▶** button (17) on the remote control or the button **6 ▶▶** (9) on the device.

The playback is interrupted and shown as a freeze frame.

Continuing playback

To continue the playback

- ⇨ press the **▶▶** button (17) on the remote control or the button **6 ▶▶** (9) on the device.

Interrupting playback

- ⇨ Press the **■** button (31) on the remote control.

The playback is interrupted, the start screen of the device and the text „PRESS PLAY TO CONTINUE“ are displayed.

Continuing playback

- ⇨ press the **▶▶** button (17) on the remote control.

Playback is continued again.

Skipping a chapter

A title of the DVD can be divided into several smaller chapters.

To jump to the next or another chapter,

- ⇨ press the **▶** button (32) once or several times on the remote control.

The playback jumps to the beginning of the next or the corresponding following chapter.

To jump to the beginning of the current or a previous chapter,

- ⇨ press the **◀** button (32) once or several times on the remote control.

The playback jumps to the beginning of the current or the corresponding previous chapter.

Repeated playback of a DVD title

A DVD is divided into different titles and chapters, which can be selected on an individual basis.

Repeated playback of a chapter or title

To repeat the current chapter,

- ⇨ press the **PLAY MODE** button (26) on the remote control.

The display shows the repeat symbol and "CHAPTER".

To repeat the current title,

- ⇨ press the **PLAY MODE** button (26) on the remote control a second time.

The display shows the repeat symbol and "TITLE".

To repeat the entire DVD,

- ⇨ press the **PLAY MODE** button (26) on the remote control a third time.

The display shows the repeat symbol and "ALL".

Cancelling repeat

If you want to cancel the repeat function,

- ⇨ press the **PLAY MODE** button (26) on the remote control repeatedly until the repeat symbol is no longer shown on the display.

Direct selection of a chapter

The remote control can also be used to directly select a chapter or a specific position (playing time).

Selecting a chapter

To directly select a chapter,

- ⇨ press the **GOTO** button (18) on the remote control.

The external display shows the GOTO menu.

- ⇨ Move the selection mark with the buttons of the remote control **▲▼** (6) to "CHAPTER".
- ⇨ Press the **ENTER** button (14) on the remote control.
- ⇨ Enter the three-digit number of the desired chapter using the numeric buttons **0** to **9** (35) on the remote control and press the **ENTER** button (14).

Playback is continued at the desired position.

DVD OPERATION

To exit the GOTO menu and continue with full playback,

- ⇒ press the **GOTO** button (18) on the remote control.

Selecting the playing time

You can directly select a specific position on the DVD by specifying the playing time of this position either in the chapter or in the title.

To jump to a specific position,

- ⇒ press the **GOTO** button (18) on the remote control.

The external display shows the GOTO menu.

- ⇒ Move the selection mark with the buttons of the remote control ▲ ▼ (6) to "TT TIME" to set the absolute playing time in the title, or to "CH TIME" to set the playing time of the current chapter.
- ⇒ Press the **ENTER** button (14) on the remote control.
- ⇒ Enter the desired position in hours, minutes and seconds using the numeric buttons 0 to 9 (35) on the remote control.

Playback is continued at the desired position.

To exit the GOTO menu and continue with full playback,

- ⇒ press the **GOTO** button (18) on the remote control.

Resuming playback at the start of the first title of a DVD

- ⇒ Press the **▶||** button (17) on the remote control.

Playback resumes at the start of the title.

Note:

For most DVDs, this is the main menu (root) of the DVD.

Displaying subtitles

To display subtitles,

- ⇒ press the **SUB-T** button (30) on the remote control.

The display information appears. The number of languages available for subtitles and the current language are displayed next to "SUBTITLE".

To change the language of the subtitles,

- ⇒ press the **SUB-T** button (30) once or several times until the subtitles are displayed in the desired language.

Note:

You can also determine in the menu of the DVD whether and in which language subtitles are displayed (see DVD menu).

Selecting the playback language

To select the playback language,

- ⇨ press the **AUDIO** button (29) once or several times on the remote control.

The display information is shown. The number of the language, the number of available playback languages and the current language are shown.

Note:

You can also select the playback language in the menu of the DVD (see DVD menu).

Changing the camera perspective

There are DVDs that offer two or more different camera perspectives for a scene.

The number of the current camera perspective and the number of possible camera perspectives is shown in the display information next to the camera symbol.

To change the camera perspective,

- ⇨ press the **ANGLE** button (20) on the remote control.

The scene is shown from the next camera perspective. The display information is shown.

Note:

You can specify in the setup menu that a camera symbol is shown if additional camera perspectives are available. For further details,

read the section “Displaying the camera perspective” in the “Set-up” chapter.

Zooming in/out of an image area

You can enlarge a freely selectable section of the movie being played up to 4 times or reduce it to one-fourth.

To enlarge the image area,

- ⇨ press the **ZOOM** button (22) once or several times on the remote control.

Every time you press the button, the central image area is enlarged incrementally. Available zoom levels are 2x, 3x and 4x.

Note:

After setting the desired zoom, you can freely move the image area with the arrow buttons (6) of the remote control.

Reducing the image area

After the maximum zoom is reached, the image is reduced with each press of the **ZOOM** button (22) in increments of 1/2, 1/3 and 1/4.

Deactivating zoom in/out

To continue viewing the movie without zoom,

- ⇨ press the **ZOOM** button (22) on the remote control repeatedly until the image is displayed without zoom in/out.

DVD OPERATION

DVD menu

The DVD menu is offered by the inserted DVD. If you insert a DVD and playback starts, the DVD menu automatically appears on the screen.

Note:

The selection options offered by the DVD menu are dependent upon the respective DVD.

The DVD menu of a DVD can offer the following:

- You can select from different languages for the playback or the subtitles.
- In addition to the actual movie, you can also view the trailer that was used in movie theatres or on television to promote the movie or view the "Making of ..." of the movie.
- A movie is divided into several sequential chapters. You can select a chapter and directly start the playback in the chapter without first having to "fast forward" to the corresponding position like you have to with a video cassette.

Displaying the DVD menu

You can end the playback at any time and display the menu of the DVD.

- ⇒ Press the **MENU** button (13) on the remote control.

Selecting menu entries

DVDs generally provide menus in which you can select among different options, such as "Start movie", "Chapter selection", etc.

To switch between the individual menu entries,

- ⇒ press one of the **arrow buttons** ▲ ▼ / ◀ ▶ (6) on the remote control.

To confirm a menu entry,

- ⇒ press the **ENTER** button (14) on the remote control.

Exiting the DVD menu

When you make a corresponding selection in the DVD menu, e.g. the playback of the movie, you automatically leave the DVD menu and the playback starts.

Displaying the title menu

You can also call the title menu directly to conveniently select the individual titles/chapters:

- ⇒ Press the **TITLE** button (34) on the remote control.

The title menu appears.

Note:

This function is not supported by all DVDs.

Playback of DVD audio

This device can also be used to play DVD audio. The functions described above can be used provided that the DVD supports them.

The following functions are particularly useful for DVD audio.

Repeated playback of a defined section of a title

You can use the remote control to define a section of a title and repeat it endlessly in a loop.

Note:

This function is operable only if an external display is connected.

To define the starting point of the section,

- ⇨ listen to a title and press the **A-B** button (28) on the remote control at the point where you want the repeat function to start.

To define the ending point of the section,

- ⇨ listen to the title again and press the **A-B** button (28) on the remote control again at the point where you want the repeat function to end.

The section of the title is repeated until you press the **A-B** button (28) again.

Programming your favourite track with the remote control

In DVD mode, you can use the remote control to program a playlist of up to 20 of your favourite tracks of the current DVD. The playlist is deleted when you remove the DVD or when you stop the playlist and exit the programming mode.

Note:

This function is operable only if an external display is connected.

Defining and starting a playlist

- ⇨ Press the **PROGRAM** button (27) on the remote control.

The programming mode is displayed. The number of available titles on the DVD is displayed and the selection mark (green) is positioned at memory location 1.

- ⇨ Enter the first title and the chapter of your playlist with the numeric buttons **0** to **9** (35).

Note:

After entering the title, the chapters available for this title are displayed.

The selection mark moves to the next memory location.

- ⇨ Enter the next titles and chapters of your playlist with the numeric buttons **0** to **9** (35).

If your playlist should have fewer than twenty titles,

- ⇨ move the selection mark with the arrow buttons (6) to "START" and press the **ENTER** button (14).

DVD OPERATION

Stopping the playlist

To end a running playlist,

- ⇨ Press the **PROGRAM** button (27) on the remote control.

The programming mode is displayed. The selection mark is positioned on "STOP".

To end the playback of the playlist,

- ⇨ press the **ENTER** button (14).

Note:

You can also edit the playlist by moving the selection mark to individual memory locations and entering a different title with the numeric buttons.

DVD setup

The setup of the device offers a variety of options to customise the device.

Calling up the setup menu

To call up the setup menu,

- ⇨ press the **SETUP** button (12) on the remote control.

Performing settings in the setup menu

The setup menu is divided into five sections: General Setup, Audio Setup, Video Setup, Preference Page and Password Setup.

- ⇨ Select one of the five sections in the setup menu using the buttons ◀▶ (6) of the remote control or the arrow buttons on the device.
- ⇨ Confirm your entry with the **ENTER** button (14) on the remote control.

The selection mark (yellow) is displayed and positioned on the first entry of the selected menu.

- ⇨ Select the desired menu item using the buttons ▲▼ (6) of the remote control or the arrow buttons on the device.
- ⇨ Confirm your entries with the **ENTER** button (14) on the remote control.
- ⇨ Perform your settings using the buttons ◀▶▲▼ (6) of the remote control or the arrow buttons on the device.

- ⇒ Confirm your entries with the **ENTER** button (14) on the remote control.

If you want to perform additional settings in other sections of the menu:

- ⇒ Press the ◀ button (6) of the remote control or the ◀ button (6) on the device to return to the selection of the menu sections.

To exit the setup menu,

- ⇒ press the **SETUP** button (12) on the remote control.

General Setup - general settings

In the general settings, you can define the type of connected display, display a symbol if more than one camera perspective is available, switching captions on and off, and set the priority for audio or video DVDs.

Selecting the monitor setting

The setting of the monitor is performed under the “TV Display” menu item.

The following monitor settings are available:

- **Normal/LB:** The DVD player is connected to a 4:3 monitor. The wide image is displayed on the screen at full width with black bars at the top and bottom edge of the screen.
- **Normal/PS:** The DVD player is connected to a 4:3 monitor. The wide image is displayed using the full height of the screen. The left and right edge of the wide image is automatically cut off.

- **WIDE:** The DVD player is connected to a 16:9 monitor. The wide image is displayed on the screen at full size.

Displaying the camera perspective

You can specify that a camera symbol is shown if more than one camera perspective is available on the DVD. For this purpose, select the setting “ON”.

The setting of the camera perspective is performed under the “Angle Mark” menu item.

Displaying captions

Captions are special subtitles that cannot be switched on/off using the subtitle function of a DVD. You can use this menu to switch these subtitles on or off. Select the setting “Off” to switch it off.

DVD/DVD audio priority

DVD audio generally contains audio data in two versions:

One high-resolution uncompressed variant and one compressed variant (e.g. in DTS or Dolby Digital).

Here you can define whether you want to listen to high-resolution audio data or to compressed audio data.

Select the “DVD Audio” setting for higher quality or “DVD Video” for the compressed version.

The setting of the priority is performed under the “Priority” menu item.

DVD OPERATION

Audio Setup

The Audio Setup allows you to control the SPDIF output of the device, set the PCM channel and set the sampling rate of the LPCM output. In addition, you can control the Dynamic Range Control (DRC) and the HDCD filter.

SPDIF setting

For the SPDIF output of the device, you can select whether an SPDIF-RAW signal, an SPDIF-PCM signal a manually controlled signal should be output or that the SPDIF output should be switched off.

Select the desired setting under "SPDIF Output".

Notes:

- The SPDIF output is not muted for traffic announcements, incoming telephone calls and navigation voice output.
- The audio data of the DVD drive are output via the SPDIF output.

PCM channel

The SPDIF output can be used to output the PCM data in the "L/R", "LS/RS" or "C/LFE" mode.

The respective setting can be performed under "PCM Channel" in the "SPDIF Output".

Setting the LPCM

This device can be used to output a linear PCM signal (LPCM) with a sampling rate of 48 K, 96 K or 192 K.

The LPCM setting is located under "LPCM OUT" in the "SPDIF Setup".

Dolby Digital Setup - Dynamic Range Control

Dynamic Range Control means that the difference between "loud" and "soft" sounds is adjusted. The volume of soft sounds is increased and that of loud sounds is lowered. You can use the DRC of the device to set the dynamics of a Dolby programme in increments from "OFF" to "Full". Select the "FULL" setting for full dynamic adjustment.

The setting of DRC is located under "Dynamic" in the "Dolby Digital Setup".

Setting the HDCD filter

If you play HDCD-DVDs or CDs (High Definition Compatible Digital), you can select a filter.

Select the desired filter under "HDCD".

Video Setup - image settings

In the Video Setup, you can perform different settings for an optimal image playback on the connected display.

Adjusting picture sharpness

To adjust the picture sharpness, you can select among the settings "High", "Medium" and "Low".

The setting for picture sharpness is located in "Quality" under "Sharpness".

Brightness

You can adjust the brightness in increments from -20 to +20.

The setting for brightness is located in "Quality" under "Brightness".

Contrast

You can adjust the contrast in increments from -16 to +16.

The setting for contrast is located in "Quality" under "Contrast".

Gamma correction

You can adjust the gamma correction for playback on TFT displays. You can select among the settings "High", "Medium", "Low", and "None".

The setting for gamma correction is located in "Quality" under "Gamma".

Colour

You can adjust the colour in increments from -9 to +9.

The setting for colour is located in "Quality" under "Hue".

Colour saturation (for NTSC only)

You can adjust the colour saturation in increments from -9 to +9.

The setting for colour saturation is located in "Quality" under "Saturation".

Luminance (for NTSC only)

You can select the settings "0T" and "1T" for luminance.

The setting for luminance is located in "Quality" under "Luma Delay".

Preferences - preferred settings

Under "Preferences", you can set the television standard of the external display, switch PBC on and off, set the preferred playback language, select the preferred language for subtitles, set the parental control, set the region, and reset the device.

To call up the preferred settings,

- ⇨ press the **■** button (31) on the remote control.
- ⇨ Press the **SETUP** button (12) on the remote control.
- ⇨ Select "Preferences Page" using the buttons **◀▶** (6) of the remote control or the arrow buttons on the device.
- ⇨ Confirm your entry with the **ENTER** button (14) on the remote control.

Setting the colour television standard of the TV device

For a perfect image quality, set the colour television standard on the device which is used by the attached monitor.

"PAL" is the standard used in Europe, "NTSC" is the standard for the American/Asiatic region.

If you select the "MULTI" setting, the standard of the DVD is used for the output.

The setting of the television standard is performed under the "TV TYPE" menu item in the "Preferences Page" menu.

Note:

The television standard can also be switched using the remote control. Press the **TV-Mode** button (21) repeatedly until the desired television standard is displayed.

Switching playback control on/off

If the Playback Control (PBC) function is switched off, the titles and chapters of a VCD/SVCD are played in ascending order. With PBC on, the VCD/SVCD is played with the predefined menus and in logical order.

The setting for PBC is located under "PBC".

Selecting the playback language

You can preselect the preferred playback language of the DVD. If the selected language is available on the DVD, the playback starts with the preset language.

The setting of the playback language is performed under the "Audio" menu item.

Selecting the language of subtitles

You can preselect the preferred language for subtitles. If the selected language for subtitles is available on the DVD, the subtitles are displayed in the preset language.

The setting of the subtitles is performed under the "Subtitle" menu item.

Selecting the language for the DVD menu

You can preselect the preferred language for the menus of the DVD. If the selected language for menus is available on the DVD, the menus of the DVD are displayed in the preset language.

The setting of the language for the DVD menu is performed in the "Disc Menu" menu item.

Parental control

You can secure the device against unauthorised use by assigning a password. In addition, you can specify a rating level.

Rating level means that some DVDs are equipped with a code that defines the age-appropriate release.

If you set a rating level that is lower than the one found on the inserted DVD, it can be played only after entering the password.

Note:

Not all DVDs support the Rating Level function.

In the menu you can define which movies can be played. These ratings follow the recommendations of the Motion Picture Association of America (MPAA).

The following options can be selected:

1 KID SAF: Approved for children

2 G: Approved for children

3 PG: Accompanying adult during playback is suggested.

4 PG 13: Accompanying adult is suggested, not suitable for children under the age of 13.

5 PG-R: Only for adolescents accompanied by an adult. Prohibited for children, contents includes violence, obscene language, etc.

6 R: Prohibited for adolescents, contents includes violence, obscene language, etc.

7 NC 17: Contents not suitable for adolescents under the age of 17.

8 ADULT: Contents for adults only: Violence, sex, etc.

Notes:

- Some blocked DVDs can be released directly at the start with YES (ENTER) and the password. Others require you to change the rating level in the setup before the playback of the DVD. This action is dependent upon the DVD.
- If you activated password protection, the age-appropriate release can only be changed after entering the password. For further details, please read the section "Activating/deactivating password protection".

The setting for the parental control can be performed in the "Parental" menu item.

Resetting the device

You can reset the device, thereby deleting all, personal setting (including the self-defined password) and re-establish the basic factory settings.

Resetting the device is performed in the "Default" menu item.

Setting password protection - Assigning a password

You can activate the password protection for the device. With activated password protection, you can change the age-appropriate release/parental control only after entering the password.

Activating/deactivating password protection

The password protection can be activated (ON) or deactivated (OFF) in the "Password Mode" menu. To change the setting, you must enter the current password using the numeric buttons ⁽³⁵⁾.

If you have not yet entered a password, use the preset password **000000**.

After you have entered the correct password, the entry marking automatically switches to "OK".

DVD OPERATION

Changing the password

You can change the preset password and define your own. The password must have six digits. To change the password, you must first enter the old password. If you have not yet assigned a password, use the preset password **000000**.

The password is changed in the “Password” menu. To change the password, you must first enter the current password with the numeric buttons (35) and then enter the new password twice.

After you have entered the correct password and entered the new password twice, the entry marking automatically switches to “OK”.

Note:

If you forgot your password, you can use the master code **136900** and assign a new password.

Exiting the setup menu

To exit the setup menu,

- ⇨ press the **SETUP** button (12) on the remote control.

Or

- ⇨ select “Exit Setup Menu” using the buttons ◀▶ (6) of the remote control or the arrow buttons on the device.
- ⇨ Confirm your entry with the **ENTER** button (14) on the remote control.

CD mode

You can use this device to play standard audio CDs, CD-Rs and CD-RWs with a diameter of 12 cm. To avoid problems when playing CDs, you should not burn CDs at speeds greater than 16x.

To ensure proper functioning, use only CDs with the Compact-Disc logo. Copy-protected CDs can cause playback problems. Blaupunkt cannot guarantee the proper functioning of copy-protected CDs!

Besides being able to play audio CDs on this device, you can also play CDs containing MP3 music files and DVDs. For further details, please read the chapters "MP3 mode" and "DVD mode".

 Risk of severe damage to the DVD/CD drive!

CD singles with a diameter of 8 cm and non-circular contoured CDs (shape CDs) must not be used.

We accept no responsibility for any damage to the DVD/CD drive that may occur as a result of the use of unsuitable DVDs/CDs.

Switching to CD mode

If there is no CD inserted in the drive,

- ⇨ switch on the device by pressing button ①.
- ⇨ Press the  button ②.

The control panel opens.

- ⇨ Gently insert the CD with its printed side uppermost into the drive until you feel some resistance.

The drive draws in the CD automatically.

You must not hinder or assist the drive as it draws in the CD.

- ⇨ Gently close the control panel whilst exerting a little pressure until you feel it click into place.



The CD starts playing.



If a CD is already inserted in the drive,

- ⇨ press the **SRC** button ⑪ on the device or the **SOURCE** button ⑪ on the remote control repeatedly until "DISC" appears on the display.

Playback begins from the point at which it was last interrupted.

Selecting tracks

- ⇨ Press one of the arrow buttons ⑥ to select the next or previous track, or press the  or  button ③② on the remote control.

If you press the  or  button ⑥ or  ③② once, the current track is played again.

Direct track selection with the remote control

In CD mode, you can directly select tracks with the remote control or select a specific playing time on the CD or in the current track.

Note:

This function is operable only if an external display is connected.

CD MODE

Track selection

- ⇒ Enter the number of the desired track directly using the numeric buttons **0** to **9** (35) of the remote control.

After entering the number, the desired track begins to play.

Or

- ⇒ Press the **GOTO** button (18) repeatedly until the external display shows "SELECT TRACK".
- ⇒ Enter the number of the desired track using the numeric buttons **0** to **9** (35), e.g. **0 2** for the second or **1 2** for the twelfth track.

After entering the number, the desired track begins to play.

Selecting the playing time on the CD

- ⇒ Press the **GOTO** button (18) repeatedly until the external display shows "DISC GO TO".
- ⇒ Enter the desired playing time in the minute-second format where you want the playback to start using the numeric buttons (35).

After entering the time, the playback is continued at the desired position.

Selecting the playing time in the current track

- ⇒ Press the **GOTO** button (18) repeatedly until the external display shows "TRACK GO TO".
- ⇒ Enter the desired playing time in the minute-second format where you want the playback in the track

to start using the numeric buttons (35).

After entering the time, the playback is continued at the desired position.

Fast track selection

To quickly select tracks backwards or forwards,

- ⇒ press and hold down one of the **▲ / ▼** buttons (6) until fast-reverse/fast-forward track selection begins.

Fast searching (audible)

To fast search backwards or forwards,

- ⇒ press and hold down one of the **<>** buttons (6) until fast searching backwards/forwards begins.

Fast searching with the remote control

You can perform a fast searching with different speeds (2x, 4x, 8x, 16x, and 32x) with the remote control.

Note:

The search speed is shown on an external display (optional equipment).

For fast searching forwards

- ⇒ press the **▶▶** button (16) on the remote control repeatedly until the desired speed is shown.

For fast searching backwards

- ⇒ press the **◀◀** button (16) on the remote control repeatedly until the desired speed is shown.

To end the searching,

- ⇨ press the **▶||** button (17) on the remote control.

Random track play (MIX)

- ⇨ Press the **1 MIX** button (9).

“MIX CD ON” appears briefly on the display and the MIX symbol is displayed. The next randomly selected track will then be played.

Cancelling MIX

- ⇨ Press the **1 MIX** button (9) again.

“MIX CD OFF” appears briefly on the display and the MIX symbol disappears.

Scanning tracks (SCAN)

You can scan (briefly play) all the tracks on the CD.

- ⇨ Press and hold down the **MENU•OK** button (7) for longer than two seconds.

The next track will then be scanned.

Note:

You can set the scanning time. For further information, please read the section entitled “Setting the scanning time” in the “Radio mode” chapter.

Cancelling SCAN and continuing listening to a track

To end the scanning process,

- ⇨ press **MENU•OK** button (7).

The currently scanned track will then continue to be played normally.

Repeating tracks (REPEAT)

If you want to repeat a track,

- ⇨ press the **RPT 4** button (9).

“REPEAT TRACK” appears briefly on the display, and the RPT symbol is shown. The track is repeated continuously until you deactivate RPT.

Cancelling REPEAT

If you want to cancel the repeat function,

- ⇨ press the **RPT 4** button (9) again.

“REPEAT ALL” appears briefly on the display, and the RPT symbol disappears. Normal playback is then resumed.

REPEAT with the remote control

In CD mode, you can select the REPEAT mode with the remote control.

To repeat a track,

- ⇨ press the **PLAY MODE** button (26) repeatedly until “TRACK” is shown on the external display next to the repeat symbol.

To cancel REPEAT,

- ⇨ press the **PLAY MODE** button (26) repeatedly until “ALL” is shown on the external display next to the repeat symbol.

CD MODE

Repeated playback of a defined section of a title

You can use the remote control to define a section of a title and repeat it endlessly in a loop.

Note:

This function is operable only if an external display is connected.

To define the starting point of the section,

- ⇨ listen to a title and press the **A-B** button (28) on the remote control at the point where you want the repeat function to start.

To define the ending point of the section,

- ⇨ listen to a title and press the **A-B** button (28) on the remote control at the point where you want the repeat function to end.

The section of the title is repeated until you press the **A-B** button (28) again.

Interrupting playback (PAUSE)

- ⇨ Press the button **6** (9).

“PAUSE” appears on the display.

Cancelling pause

- ⇨ During the pause, press the button **6** (9).

Playback is continued.

You can also interrupt and continue playback using the **▶||** button (17) on the remote control.

Changing the display

You can select different displays for CD mode:

- “NORMAL MODE”:
First line: Track number
Second line: Playing time
- “INFO MODE”:
First line: Track number and playing time.
Second line: CD text (if available)
- “CLOCK MODE”:
First line: Track number and playing time.
Second line: CD text (if available) and time
- “MINIMAL MODE”:
The title number is displayed on the top line.

Note:

CD text can only be displayed if the appropriate information is contained on the CD.

To switch between the display options,

- ⇨ press the **DIS•ESC** button (5) once or several times until the desired display is shown.

Display on an external display

In CD mode, the following information is always shown on an external display, independent of the selected display of the device display:

- the number of the current track,
- the number of tracks on the CD,
- the track information from the CD text (if available)

and

- the playing time of the track (Single Elapsed)
- or
- the remaining playing time of the track (Single Remain)
- or
- the elapsed playing time of the CD (Total Elapsed)
- or
- the remaining playing time of the CD (Total Remain).

To select one of the different time display options,

- ⇨ press the **DISPLAY** button (19) on the remote control repeatedly until the desired information is shown on the external display.

Displaying CD text

Some CDs include CD text. The CD text might contain the names of the artist, album and tracks.

If the CD text is available on the CD, it is shown on the second line of the display in Info Mode and Clock Mode. The CD text is shown as scrolling text on the display with every track change. After the CD text is displayed once, the first 13 characters of the CD text of the current track are displayed.

Note:

The CD text is displayed as scrolling text if it contains more than 13 characters in Info mode or more than 8 characters in Clock mode.

Scrolling CD text again

You can re-scroll the displayed CD text at any time in Info Mode.

- ⇨ Briefly press the **5 SCL** button (9).

Programming your favourite track with the remote control

In CD mode, you can use the remote control to program a playlist of up to 20 of your favourite tracks of the current CD. The playlist is deleted when you remove the CD or when you stop the playlist and exit the programming mode.

Note:

This function is operable only if an external display is connected.

Defining and starting a playlist

- ⇨ Press the **PROGRAM** button (27) on the remote control.

The programming mode is displayed. The number of available tracks on the CD is displayed and the selection mark (green) is positioned at memory location 1.

- ⇨ Enter the first track of your playlist with the numeric buttons **0** to **9** (35).

The selection mark moves to the next memory location.

- ⇨ Enter the next track of your playlist with the numeric buttons **0** to **9** (35).

If your playlist should have fewer than 20 tracks,

- ⇨ move the selection mark with the arrow buttons (6) to "START" and press the **ENTER** button (14).

Note:

After you have programmed a playlist and exited the menu with "EXIT", the playlist is not saved.

Stopping the playlist

To end a running playlist,

- ⇨ Press the **PROGRAM** button (27) on the remote control.

The programming mode is displayed. The selection mark is positioned on "STOP". To end the playback of the playlist,

- ⇨ press the **ENTER** button (14).

Notes:

- If you selected "STOP" and confirmed it with the **ENTER** button (14), the playlist is deleted.
- If you want to exit the display of the playlist without deleting the playlist, mark "EXIT" and confirm it with the **ENTER** button (14).

Ejecting a CD

- ⇨ Press the  button (2).

The control panel opens out towards you.

- ⇨ Press the eject button next to the CD compartment.

The CD is ejected.

- ⇨ Remove the CD and close the control panel.

Notes:

- If a CD is ejected, the drive will automatically draw it back in again after approx. 10 seconds.
- CDs can also be ejected if another audio source is active.

MP3/WMA mode

You can also use this car sound system to play DVDs, CD-Rs and CD-RWs that contain MP3 music files. You can also play WMA files. The operation for playing MP3 and WMA files is identical.

Notes:

- WMA files with Digital Rights Management (DRM) from online music shops cannot be played with this device.
- WMA files can only be played back safely if they were created with Windows Media-Player version 8.

Preparing an MP3/WMA CD

The various combinations of DVD/CD burners, DVD/CD burning software and DVD/CD blanks may lead to problems arising with the device's ability to play certain CDs. If problems occur with your own burned DVDs/CDs, you should try another brand of DVD/CD blanks or choose another colour of CD blanks. To avoid problems when playing CDs, you should not burn DVDs/CDs at speeds greater than 16x.

The format of the DVD/CD must be ISO 9660 Level 1/Level 2 or Joliet. Other formats cannot be played reliably.

You can create a maximum of 254 directories on a DVD/CD. You can use this device to access each of these directories.

Up to 599 MP3 files in one directory can be managed with this device. The maximum number of files per CD/DVD

is 150,000, the maximum directory depth is five.

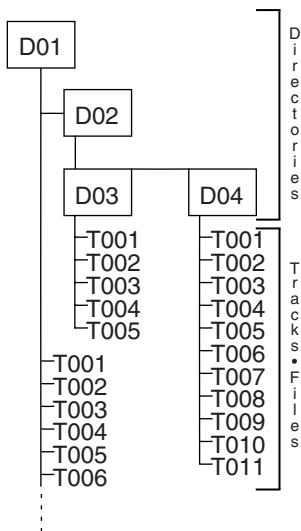

You can name each directory using a PC. The device is capable of displaying the directory name. Name the directories and tracks/files using your CD burner software. The software's instruction manual will provide details on how to do this.

Note:

When naming directories and tracks/files you should avoid using accents and special characters. You can use a maximum of 32 characters (including the ".MP3" or ".WMA" file extension) for track names and directory names.

If you like your files to be in the correct order, you should use burner software that places files in alphanumerical order. If your software does not provide this feature you also have the option of sorting the files manually. For this purpose, you must enter a number in front of each file name, e.g. "001", "002", etc. The leading zeros must also be entered.

MP3 tracks can contain additional information such as the artist, album and track names (ID3 tags). This device can display ID3 tags (version 1).

When creating (coding) MP3 files from audio files, you should use bit rates from 80 to 320 kbit/s and sampling rates of 32, 44 and 48 kHz.

This device can only play MP3 files that have the ".MP3" file extension.

Notes:

To ensure uninterrupted playback,

- do not try changing the file extension to ".MP3" of any files other than MP3 files and then attempt to play them! The device will ignore these invalid files during playback.
- Do not use "mixed" CDs containing both non-MP3 data and MP3 tracks (the device only reads MP3 files during MP3 playback).
- Do not use mix-mode CDs containing both CD-audio tracks and MP3 tracks. If you try playing a mix-mode CD, the device will only play the CD-audio tracks.

MP3/WMA MODE

Switching to MP3 mode

MP3 mode is activated in the same way as normal CD mode. For further information, please read the section entitled “Switching to CD mode” in the “CD mode” chapter.

If you connected an external display, the following information is displayed after the CD is read and the MP3/WMA playback has started:

- Number of the track and number of tracks in the directory.
- Bit rate of the file.
- Elapsed playing time and total playing time of the track.
- Name of the directory.
- In the left column, the list of tracks in the directory.
- In the right column, MP3 information from the ID tags (only if available on the DVD/CD).

Setting the display (internal display)

Configuring the default display

You can display various types of information on the current track:

1. “NORMAL MODE”:
First line: Type of file (MP3 or WMA), number of track and playing time.
Second line: Track name
2. “INFO MODE”:
First line: Track name.
Second line: MP3-ID-TAG (if available and activated, see “Selecting MP3 info”)

Note:

The system can display MP3-ID tags (version 1) if they have been saved with the MP3 files (for further information, please read the instructions that came with your PC’s MP3 software or burner software).

3. “MP3 BROWSE MODE”:
First line: Name of current track
Second line: Name of next track.
4. “CLOCK MODE”:
First line: Type of file (MP3 or WMA), number of track and playing time.
Second line: MP3 info and time.

To switch between the different display options,

⇨ press the **DIS•ESC** button (5).

Selecting the directory on the device

For convenient navigation in the data structure of the CD, you can display the current and the following directory on the two lines of the display. The directories are displayed with the names that you created when burning the CD. Whilst the directories are being displayed, you can use the arrow buttons to display and select all the available directories.

⇨ During the MP3 playback, press the **▼** or **▲** button (6).

The browse mode is automatically started, the current track is displayed on the first line of the display and the next track is displayed on the second line.

⇨ Press the **V** or **^** button (6) repeatedly until the first line of the display shows a *D*.

⇨ Press the **>** button (6).

The names of the current and the following directory are shown on the display.

If you want to select a directory,

⇨ press one of the **V** / **^** buttons (6) repeatedly until the directory is shown in the **top** line of the display and then press the **>** button (6).

The selected directory is opened. The tracks contained in the directory are displayed in browse mode.

⇨ Press the **V** or **^** button (6) repeatedly until the first line of the display shows the desired track.

⇨ Press the **>** button (6).

The playback starts, the browse mode is automatically ended after approx. 10 seconds.

Selecting a track on the device

Selecting tracks/files using the arrow buttons (Normal, info and clock mode)

To move up or down to another track/file in the current directory,

⇨ press the **<** or **>** button (6) once or several times.

A single press of **<** button (6) restarts the current track, if it previously played for more than 3 seconds.

Selecting tracks in browse mode

Browse mode conveniently allows you to view the tracks contained in a directory and then select a particular track.

⇨ During MP3 playback, repeatedly press the **DIS•ESC** button (5) until "MP3 BROWSE MODE" is displayed.

⇨ Press the **V** or **^** button (6) to display all the tracks contained in the directory one after another.

⇨ If you want to select the track shown on the upper display line, press the **>** button (6).

Selecting a directory/track with the remote control

In MP3 mode, you can directly select directories and tracks using the remote control.

Note:

This function is operable only if an external display is connected.

Track selection in the same directory

⇨ Enter the number of the desired track directly using the numeric buttons **0** to **9** (35) of the remote control.

After entering the number, the desired track begins to play.

Or

To move up or down to another track/file in the current directory,

⇨ press the **◀** or **▶** button (32) once or several times.

MP3/WMA MODE

Selecting a directory

To select a directory with the remote control,

- ⇨ press the ▲ button (6) repeatedly until the selection mark is positioned on the directory symbol.

- ⇨ Press the **ENTER** button (14).

The directory list is shown on the external display.

- ⇨ Press the ▼ or ▲ button (6) to mark the desired directory.

- ⇨ Press the **ENTER** button (14).

The track list of the directory is displayed.

- ⇨ Press the ▼ or ▲ button (6) to mark a track in the directory.

- ⇨ Press the **ENTER** button (14).

The desired track is started.

Selecting a track from the track list

You can display a list of all tracks of a DVD/CD on the external display and select a track from the list.

- ⇨ Press the **PROGRAM** button (27).

The track list is displayed.

- ⇨ Enter the number of the desired track directly using the numeric buttons **0** to **9** (35) of the remote control.

After entering the number, the desired track begins to play.

Or

To move up or down to another track/file in the current directory,

- ⇨ press the ▼ or ▲ button (6) once or several times to move the selection mark to the desired track.

- ⇨ Press the **ENTER** button (14).

The desired track is started.

Fast search

To fast search backwards or forwards,

- ⇨ press and hold down the < or > button (6) until fast searching backwards/forwards begins.

Fast searching with the remote control

You can perform a fast searching with different speeds (2x, 4x, 8x, 16x, and 32x) with the remote control.

Note:

The search speed is shown on an external display.

For fast searching forwards

- ⇨ press the ►► button (16) on the remote control repeatedly until the desired speed is shown.

For fast searching backwards

- ⇨ press the ◀◀ button (16) on the remote control repeatedly until the desired speed is shown.

To end the searching,

- ⇨ press the ►|| button (17) on the remote control.

Random track play – MIX

To play the tracks in the current directory in random order,

- ⇨ briefly press the **1 MIX** button (9).

“MIX ON” and the MIX symbol appear on the display.

Cancelling MIX

To cancel MIX,

- ⇨ press the **1 MIX** button (9) repeatedly until “MIX OFF” is displayed.

The MIX symbol disappears.

The Repeat function is automatically activated, and the display shows the RPT symbol.

Scanning tracks – SCAN

You can scan (briefly play) all the tracks on the CD.

- ⇨ Press and hold down the **MENU•OK** button (7) for longer than two seconds.

The next track will then be scanned. “SCAN” briefly appears on the display.

Notes:

- You can set the scanning time. For further information, please read the section entitled “Setting the scanning time” in the “Radio mode” chapter.
- The Scan function cannot be activated if it is started at the last title of a directory.

Cancelling SCAN and continuing listening to a track

- ⇨ Press and hold down the **MENU•OK** button (7) for longer than two seconds.

The currently scanned track will then continue to be played normally.

Repeated playback of individual tracks or entire directories – REPEAT

To play the current track repeatedly,

- ⇨ briefly press the **4 RPT** button (9).

“REPEAT TRACK” and RPT appear briefly on the display.

To repeat the whole directory,

- ⇨ press the **4 RPT** button (9) again.

“REPEAT DIR” appears briefly on the display.

Cancelling REPEAT

To stop the current track or current directory from being repeated,

- ⇨ press the **4 RPT** button (9) repeatedly until “REPEAT OFF” is displayed.

RPT disappears from the display.

REPEAT with the remote control

In CD mode, you can select the REPEAT mode with the remote control.

Note:

This function is operable only if an external display is connected.

MP3/WMA MODE

To repeat a track,

- ⇨ press the **PLAY MODE** button (26) repeatedly until “REPEAT ONE” is shown on the lowest line of the external display.

To repeatedly play all the tracks of a directory,

- ⇨ press the **PLAY MODE** button (26) repeatedly until “REPEAT FOLDER” is shown on the lowest line of the external display.

To cancel REPEAT,

- ⇨ press the **PLAY MODE** button (26) repeatedly until “FOLDER” is shown on the lowest line of the external display.

Repeated playback of a defined section of a title

You can use the remote control to define a section of a title and repeat it endlessly in a loop.

Note:

This function is operable only if an external display is connected.

To define the starting point of the section,

- ⇨ listen to a title and press the **A-B** button (28) on the remote control at the point where you want the repeat function to start.

To define the ending point of the section,

- ⇨ continue listening to the title and press the **A-B** button (28) on the remote control at the point where you want the repeat function to end.

The section of the title is repeated until you press the **A-B** button (28) again.

Interrupting playback (PAUSE)

- ⇨ Press the **▶** button 6 (9).

“PAUSE” appears on the display.

Cancelling pause

- ⇨ During the pause, press the button **▶** 6 (9).

Playback is continued.

You can also interrupt and continue playback using the **▶||** button (17) on the remote control.

Selecting MP3 info

If you want to select the “MP3 INFO” display mode, you first have to activate this function in the menu. In order for the system to be able to display MP3 information, the information must be stored on the CD in the form of ID tags together with the MP3 files.

- ⇨ Press the **MENU•OK** button (7).
- ⇨ Press the **V** or **^** button (6) repeatedly until “VARIOUS MENU” appears on the display.
- ⇨ Press the **MENU•OK** button (7).
- ⇨ Press the **V** or **^** button (6) repeatedly until “MP3 INFO” appears on the display.
- ⇨ Use the **<>** buttons (6) to switch between the “ON” and “OFF” options.

When you have finished making your changes,

- ⇨ press the **MENU•OK** button (7) and then the **DIS•ESC** button (5) to exit the menu.

Displaying scrolling texts (scroll)

The selected information title, track names or file name and directory name are shown once as scrolling text when the title changes.

To display the information again as scrolling text,

- ⇨ briefly press the **5 SCL** button (9).

Note:

The information is displayed as scrolling text if it contains more than 13 characters in Normal/Info mode, more than 11 characters in Browse mode or more than 8 characters in Clock mode.

CD-changer mode

Note:

Information on handling CDs, inserting CDs and operating the CD changer can be found in the operating instructions supplied with your CD changer.

Switching to CD-changer mode

- ⇨ Press **SRC** (11) on the device or the **SOURCE** button (11) on the remote control repeatedly until "CDC" appears on the display.

The device starts playing the first CD that the CD changer detects.

Selecting CDs

To move up or down to another CD,

- ⇨ press the **▼** or **▲** button (6) on the device or the **▼** or **▲** button (6) of the remote control once or several times.

Note:

The device will ignore empty CD slots in the changer and slots containing invalid CDs.

Selecting tracks

To move up or down to another track on the current CD,

- ⇨ press the **>** or **<** button (6) on the device or the **▶** or **◀** button (6) of the remote control once or several times.

CD-CHANGER MODE

Fast searching (audible)

To fast search backwards or forwards,

- ⇨ hold one of the <> buttons (6) pressed on the device or the ◀ or ▶ button (6) of the remote control until the fast searching backwards or forwards starts.

Changing the display

You can choose from various display options in CD mode:

- “NORMAL MODE”:
First line: Track number
Second line: CD number/CD name and playing time
- “CLOCK MODE”:
First line: Track number.
Second line: CD number/CD name and clock time
- „MINIMAL MODE”:
First line: Track number.

To switch between the display options,

- ⇨ press the **DIS•ESC** button (5).

In the menu you can choose to display the CD name (if available) instead of the CD number. (For further information, please read the “Naming CDs” section):

- ⇨ Press the **MENU•OK** button (7).
- ⇨ Press the **V** or **^** button (6) repeatedly until “VARIOUS MENU” appears on the display.

- ⇨ Press the **MENU•OK** button (7).

- ⇨ Press the **V** or **^** button (6) repeatedly until “CD NAME” or “DISC NUMBER” appears on the display.

- ⇨ Use the <> buttons (6) to switch between the “CD NAME” and “DISC NUMBER” options.

When you have finished making your changes,

- ⇨ press the **MENU•OK** button (7) and then the **DIS•ESC** button (5) to exit the menu.

Repeating individual tracks or whole CDs (REPEAT)

To repeat the current track,

- ⇨ briefly press the **RPT 4** button (9).

“REPEAT TRACK” appears briefly and RPT lights up on the display.

To repeat the current CD,

- ⇨ press the **RPT 4** button (9) again.

“REPEAT CD” appears briefly and RPT lights up on the display.

Cancelling REPEAT

To stop the current track or current CD from being repeated,

- ⇨ repeatedly press button **RPT 4** (9) until “REPEAT OFF” appears in the display and RPT disappears.

Random track play (MIX)

To play the tracks on the current CD in random order,

- ⇨ briefly press the **1 MIX** button (9).

“MIX CD” appears briefly and MIX lights up on the display.

To play the tracks on all inserted CDs in random order,

- ⇨ briefly press the **1 MIX** button (9).

“MIX ALL” appears briefly and MIX lights up on the display.

Cancelling MIX

- ⇨ Press the **1 MIX** button (9) repeatedly until “MIX OFF” is displayed.

Scanning all tracks on all CDs (SCAN)

To scan (briefly play) all the tracks on all the inserted CDs in ascending order,

- ⇨ press and hold down the **MENU•OK** button (7) for longer than two seconds.

“SCAN” and the selected display mode appear alternately on the display.

Note:

You can set the scanning time. For further information, please read the section entitled “Setting the scanning time” in the “Radio mode” chapter.

Stopping SCAN

To stop scanning,

- ⇨ press and hold down the **MENU•OK** button (7) for longer than two seconds.

The currently scanned track will then continue to be played normally.

Naming CDs

The car sound system allows you to assign names for up to 30 CDs so that you can recognise them more easily. The names can be a maximum of seven characters long.

“CD NAME FULL” will appear on the display if you try assigning more than 30 names.

Entering/editing CD names

- ⇨ Listen to the CD that you want.
- ⇨ Press the **MENU•OK** button (7).
- ⇨ Press the **V** or **Λ** button (6) repeatedly until “VARIOUS MENU” appears on the display.
- ⇨ Press the **MENU•OK** button (7).
- ⇨ Press the **V** or **Λ** button (6) repeatedly until “CD NAME EDIT” appears on the display.
- ⇨ Press the **MENU•OK** button (7).

You will now enter editing mode.

If your CD does not have a name yet, “ABCDEFGH” appears on the display. The currently active text input position flashes.

CD-CHANGER MODE

- ⇨ Use the **V / ^** buttons (6) to select the character that you want. If you want an empty space, simply select the underscore.
- ⇨ Use the **< or >** button (6) to move from one text input position to another.

When you have finished making your changes,

- ⇨ press the **MENU•OK** button (7) and then the **DIS•ESC** button (5) to exit the menu.

Deleting a CD name

- ⇨ Listen to the CD whose name you want to delete.
- ⇨ Press the **MENU•OK** button (7).
- ⇨ Press the **V** or **^** button (6) repeatedly until "VARIOUS MENU" appears on the display.
- ⇨ Press the **MENU•OK** button (7).
- ⇨ Press the **V** or **^** button (6) repeatedly until "CD NAME EDIT" appears on the display.
- ⇨ Press the **MENU•OK** button (7).

The name of the current CD is displayed.

- ⇨ Press and hold down the **MENU•OK** button (7). After approx. four seconds you will hear a beep and "DELETE NAME" appears on the display.
- ⇨ Release the **MENU•OK** button (7).

The CD name will be deleted.

- ⇨ You can return to the menu by pressing the **MENU•OK** button (7).

Deleting all CD names

You can delete all the CD names stored in the car sound system.

- ⇨ Listen to a CD.
- ⇨ Press the **MENU•OK** button (7).
- ⇨ Press the **V** or **^** button (6) repeatedly until "VARIOUS MENU" appears on the display.
- ⇨ Press the **MENU•OK** button (7).
- ⇨ Press the **V** or **^** button (6) repeatedly until "CD NAME EDIT" appears on the display.
- ⇨ Press the **MENU•OK** button (7).

The name of the current CD is displayed.

- ⇨ Press and hold down the **MENU•OK** button (7). After approx. four seconds you will hear a beep and "DELETE NAME" appears on the display. Continue holding the button pressed down until you hear a second beep and "DELETE ALL" appears on the display.
 - ⇨ Release the **MENU•OK** button (7).
- The CD names will be deleted.
- ⇨ To exit the menu, press the **MENU•OK** button (7) and twice **DIS•ESC** (5).

CLOCK time

Displaying the time

You can make the clock time appear continuously in the bottom part of the display while any audio source is activated. For further information, please read the "Configuring the display" sections in the relevant chapters.

Setting the clock manually

To set the clock time manually,

- ⇨ press the **MENU•OK** button (7).
- ⇨ Press the **V** or **Λ** button (6) repeatedly until "CLOCK MENU" appears on the display.
- ⇨ Press the **MENU•OK** button (7).
- ⇨ Press the **Λ** or **V** button (6) repeatedly until "CLOCK SET" appears on the display.
- ⇨ Press the **MENU•OK** button (7).

The time appears on the display. The hours flash and can be adjusted.

- ⇨ Set the hours using the **Λ / V** buttons (6).

Once the hours are set,

- ⇨ press the **>** button (6).

The minutes flash.

- ⇨ Set the minutes using the **Λ / V** buttons (6).
- ⇨ Press the **MENU•OK** button (7) and then the **DIS•ESC** button (5).

Selecting 12/24-hour clock mode

- ⇨ Press the **MENU•OK** button (7).
- ⇨ Press the **V** or **Λ** button (6) repeatedly until "CLOCK MENU" appears on the display.
- ⇨ Press the **MENU•OK** button (7).
- ⇨ Press the **Λ** or **V** button (6) repeatedly until "24 HOUR MODE" or "12 HOUR MODE" appears on the display.
- ⇨ Press the **<** or **>** button (6) to switch between the modes.

When you have finished making your changes,

- ⇨ press the **MENU•OK** button (7) and then the **DIS•ESC** button (5) to exit the menu.

Displaying the time continuously when the device is off and the ignition is on

To display the time when the device is off and the vehicle ignition is on,

- ⇨ press the **MENU•OK** button (7).
- ⇨ Press the **V** or **Λ** button (6) repeatedly until "CLOCK MENU" appears on the display.
- ⇨ Press the **MENU•OK** button (7).

- ⇨ Press the **▲** or **▼** button (6) repeatedly until “OFF CLOCK OFF” or “OFF CLOCK ON” appears on the display.
- ⇨ Press the **<** or **>** button (6) to switch between the ON/OFF settings.

When you have finished making your changes,

- ⇨ press the **MENU•OK** button (7) and then the **DIS•ESC** button (5) to exit the menu.

Sound

You can adjust the sound settings (bass and treble) separately for each source (radio, DVD/CD, CD changer, AUX). The volume distribution settings (balance and fader) apply to all the audio sources.

Note:

Instead of the **AUDIO** button (10) on the device, you can also use the **3D** button (10) on the remote control.

Adjusting the bass

- ⇨ Press the **AUDIO** button (10).
- ⇨ Press the **<** or **>** button (6) to adjust the bass.
- ⇨ Press the **AUDIO** (10) button to close the menu, or press the **▲** or **▼** button (6) to make further changes to the settings.

Adjusting the treble

- ⇨ Press the **AUDIO** button (10).
- ⇨ Press the **▲** or **▼** button (6) repeatedly until “TREBLE” appears on the display.
- ⇨ Press the **<** or **>** button (6) to adjust the treble.
- ⇨ Press the **AUDIO** (10) button to close the menu, or press the **▲** or **▼** button (6) to make further changes to the settings.

Setting the left/right volume distribution (balance)

To adjust the left/right volume distribution (balance),

- ⇨ Press the **AUDIO** button (10).
- ⇨ Press the **▲** or **▼** button (6) repeatedly until "BALANCE" appears on the display.
- ⇨ Press the **<** or **>** button (6) to adjust the balance (right/left).
- ⇨ Press the **AUDIO** (10) button to close the menu, or press the **▲** or **▼** button (6) to make further changes to the settings.

Adjusting the front/rear volume distribution (fader)

To adjust the front/rear volume distribution (fader),

- ⇨ Press the **AUDIO** button (10).
- ⇨ Press the **▲** or **▼** button (6) repeatedly until "FADER" appears on the display.
- ⇨ Press the **<** or **>** button (6) to adjust the fader (front/rear).
- ⇨ Press the **AUDIO** (10) button to close the menu, or press the **▲** or **▼** button (6) to make further changes to the settings.

X-BASS

X-BASS means raising the bass at low volume.

Adjusting the X-BASS boost

The X-BASS boost (Level) can be set in steps ranging from 0 to 6 for one of the following frequencies: 32 Hz, 40 Hz, 50 Hz, 63 Hz or 80 Hz.

"LVL 0" means that no X-BASS boost will be applied, and "LVL 6" means that X-BASS will be boosted by the maximum amount.

- ⇨ Press the **AUDIO** button (10) on the device or **3D** (10) on the remote control.

"BASS" appears on the display.

- ⇨ Press the **▲** or **▼** button (6) repeatedly until "X-BASS" appears on the display.
- ⇨ Press the **MENU•OK** button (7) or **ENTER** (14) on the remote control.

The X-Bass menu is displayed. The frequency flashes.

- ⇨ Press the **▲** or **▼** button (6) to set the frequency that you want.
- ⇨ Press the **>** button (6).

The boost level (LVL) flashes.

- ⇨ Press the **▲** or **▼** button (6) to set the boost level that you want.
- ⇨ Press the **AUDIO** button (10).

EQUALIZER

Equalizer

The device features a digital equalizer DEQ.

This means you have three 5-band equalizers, six sound presets and seven vehicle presets at your disposal.

You can configure the EQ1 - EQ3 equalizers manually. When doing so you can adjust (boost or reduce) one frequency of an equalizer band as well as the quality factor, i.e. the width of the filter.

The following bands are available:

- LOW 1 20 - 250 Hz
- LOW 2 20 - 250 Hz
- HIGH 1 315 - 20,000 Hz
- HIGH 2 315 - 20,000 Hz
- HIGH 3 315 - 20,000 Hz

Switching the equalizer on/off

To switch the equalizer on/off,

⇨ press the **DEQ** button (8).

The equalizer menu appears on the display.

To activate the equalizer,

⇨ select one of the sound presets or adjust the equalizer manually. For further details on this, please read the sections that follow in this chapter.

To deactivate the equalizer,

- ⇨ press the **▲** or **▼** button (6) repeatedly until “EQ OFF” appears on the display.
- ⇨ Press the **MENU•OK** button (7) and then the **DIS•ESC** (5).

Selecting sound presets

You can select sound presets for the following music types.

- POP
- ROCK
- TECHNO
- JAZZ
- CLASSIC
- SPEECH

The settings for these music styles have already been programmed.

- ⇨ Press the **DEQ** button (8).
- ⇨ Press the **▲** or **▼** button (6) repeatedly until “SOUND PRE-SETS” appears on the display.
- ⇨ Press the **MENU•OK** button (7) or **ENTER** (14) on the remote control.
- ⇨ Press the **<** or **>** button (6) repeatedly until the sound preset that you want is displayed.
- ⇨ Press the **MENU•OK** button (7) and then the **DIS•ESC** (5).

The settings are saved.

Selecting vehicle presets

You can select optimised equalizer settings for the following vehicle types:

- COMPACT
- 4DOOR
- CONVERT
- VAN
- ROADSTER
- MINI
- TRUCK

The settings for these vehicle types have already been programmed.

- ⇨ Press the **DEQ** button (8).
- ⇨ Press the **▲** or **▼** button (6) repeatedly until “CAR PRESETS” appears on the display.
- ⇨ Press the **MENU•OK** button (7) or **ENTER** (14) on the remote control.
- ⇨ Press the **<** or **>** button (6) repeatedly until the vehicle type that you want is displayed.
- ⇨ Press the **MENU•OK** button (7) and then the **DIS•ESC** (5).

The settings are saved.

Manually adjusting the equalizer

Notes on adjusting the settings

We recommend you use a CD that you are familiar with for making changes to the settings.

Before adjusting the equalizer, set the sound and volume distribution settings to zero and deactivate X-BASS. For further information, please read the “Sound” chapter.

- ⇨ Listen to the CD.
- ⇨ What kind of impression does the sound make?
- ⇨ Now read the “Sound impression” column in the table entitled “Help adjusting the equalizer”.
- ⇨ Set the equalizer values as described in the “Measures” column.

Making adjustments

- ⇨ Press the **DEQ** button (8).
- ⇨ Press the **▲** or **▼** button (6) repeatedly until “MANUAL EQ” appears on the display.
- ⇨ Press the **MENU•OK** button (7) or **ENTER** (14) on the remote control.
- ⇨ Press the **▲** or **▼** button (6) repeatedly until the equalizer that you want to configure (“USER EQ1”, “USER EQ2” or “USER EQ3”) appears on the display.
- ⇨ Press the **MENU•OK** button (7).

EQUALIZER

⇒ Press the **▲** or **▼** button (6) repeatedly until the equalizer band that you want to configure (“LOW1”, “LOW2”, “HIGH1”, “HIGH2” or “HIGH3”) appears on the display.

⇒ Press the **MENU•OK** button (7).

⇒ Press the **▲** or **▼** button (6) repeatedly until the frequency that you want is displayed.

⇒ Press the **MENU•OK** button (7).

The top line displays the GAIN and the quality factor “Q”. The gain setting flashes. You can use the quality factor to adjust the width of the filter. The higher you set the value for the quality factor the more directly the filter will be applied to the selected frequency.

To adjust the gain,

⇒ press the **▲** or **▼** button (6).

To adjust the quality factor,

⇒ press the **>** button (6).

The quality factor setting flashes.

⇒ Press the **▲** or **▼** button (6) repeatedly until the setting that you want is displayed.

Note:

Please note that you can boost or reduce one frequency in each equalizer band. Proceed in the way described above with all the equalizer bands that you want to adjust.

⇒ Press the **MENU•OK** button (7) and then the **DIS•ESC** button (5) repeatedly or the **DEQ** button (8).

The settings are saved.

Help adjusting the equalizer

Sound Impression/problem	Measures
Bass sound is too weak.	Increase bass with Frequency: 32 to 160 Hz Gain: +4 to +6
Dirty bass. Booming sound. Unpleasant pressure.	Reduce the lower mid level with Frequency: 400 Hz Gain: approx. -4
Sound very much in the foreground, aggressive, no stereo effect.	Reduce the mid level with Frequency: 1,000 to 2,500 Hz Gain: -4 to -6
Dull sound. Little clarity. No brilliance to the instruments.	Boost the treble range with Frequency: 6,300 to 10,000 Hz Gain: +2 to +4

DISPLAY

Adjusting the display settings

Adjusting the display brightness

If your car sound system is connected as described in the installation instructions, the display brightness of the internal display switches with the headlights. You can adjust the display brightness separately for night and day in steps ranging from 1 - 16.

Note:

The brightness of a connected display can be set in the DVD setup. For further details, read the section "DVD setup" in the "DVD mode" chapter.

- ⇨ Press the **MENU•OK** button (7).
- ⇨ Press the **V** or **Λ** button (6) repeatedly until "DISPLAY MENU" appears on the display.
- ⇨ Press the **MENU•OK** button (7).

OR

- ⇨ Press the **DIMMER** button (23) on the remote control.
- ⇨ Press the **Λ** or **V** button (6) repeatedly until "DAY" or "NIGHT" appears on the display with the current setting.
- ⇨ Press the **<** or **>** button (6) to switch between the brightness levels.

When you have finished making your changes,

- ⇨ press the **MENU•OK** button (7) and then the **DIS•ESC** button (5) to exit the menu or the **DIMMER** button (23) on the remote control.

Adjusting the viewing angle

You can adjust the display's viewing angle to suit the installation position of the device in your vehicle.

- ⇨ Press the **MENU•OK** button (7).
- ⇨ Press the **V** or **Λ** button (6) repeatedly until "DISPLAY MENU" appears on the display.
- ⇨ Press the **MENU•OK** button (7) or the **DIMMER** button (23) on the remote control
- ⇨ Press the **Λ** or **V** button (6) repeatedly until "ANGLE" appears on the display with the current setting.
- ⇨ Press the **<** or **>** button (6) to adjust the viewing angle.

When you have finished making your changes,

- ⇨ press the **MENU•OK** button (7) and then the **DIS•ESC** button (5) or the **DIMMER** button (23) on the remote control to exit the menu.

External audio sources

In addition to the CD changer, you can also connect another external audio source equipped with a line output. If no CD changer is connected to the device, you can connect two external audio sources. Audio sources can, for example, be portable CD players, MiniDisc players or MP3 players.

The AUX input must be activated in the menu.

An adapter cable is needed to connect an external audio source instead of a CD changer. You can obtain this cable (Blaupunkt no.: 7 607 897 093) from your authorised Blaupunkt dealer.

Information about where to connect an audio source to the AUX2 input can be found in the installation instructions.

Switching the AUX input on/off

- ⇨ Press the **MENU•OK** button (7).
- ⇨ Press the **V** or **^** button (6) repeatedly until “AUX MENU” appears on the display.
- ⇨ Press the **MENU•OK** button (7).
- ⇨ Repeatedly press the **V** or **^** button (6) until “AUX2” or “AUX1” appears on the display.

If a CD changer is connected, “AUX1” is not available.

- ⇨ Use the **<>** buttons (6) to switch between the “ON” and “OFF” options.

When you have finished making your changes,

- ⇨ press the **MENU•OK** button (7) and then the **DIS•ESC** button (5) to exit the menu.

Note:

If the AUX input is switched on, you can select it by pressing the **SRC** button (11).

AMPLIFIER/SUB-OUT

Amplifier/sub-out

The car sound system provides connections that allow you to connect external amplifiers. In addition, you can connect an amplifier to the integrated low-pass filter to operate a subwoofer. For this purpose, the amplifiers must be connected as described in the installation instructions.

Switching the internal amplifier on/off

If you are using external amplifiers, you can switch off the device's internal amplifier ("INT AMP OFF" setting).

Note:

Please check this setting if the loudspeakers do not emit any sound.

- ⇨ Press the **MENU•OK** button (7).
- ⇨ Press the **V** or **Λ** button (6) repeatedly until "VARIOUS MENU" appears on the display.
- ⇨ Press the **MENU•OK** (7), to display the menu.
- ⇨ Press the **V** or **Λ** button (6) repeatedly until "INT AMP ON" or "INT AMP OFF" appears on the display.
- ⇨ Use the **<>** buttons (6) to choose between "INT AMP ON" and "INT AMP OFF".

When you have finished making your changes,

- ⇨ press the **MENU•OK** button (7) and then the **DIS•ESC** button (5) to exit the menu.

Switching the dual zone on/off

If you connected the RC 13 H remote control (available as optional equipment) via an adapter, the rear loudspeakers are switched off. You can listen to the audio playback from the DVD/CD mode via the headphone outputs of the RC 13 H while the driver listens to a different source via the front loudspeakers.

- ⇨ Press the **MENU•OK** button (7).
- ⇨ Press the **V** or **Λ** button (6) repeatedly until "VARIOUS MENU" appears on the display.
- ⇨ Press the **MENU•OK** (7), to display the menu.
- ⇨ Press the **V** or **Λ** button (6) repeatedly until "DUAL ZONE ON" or "DUAL ZONE OFF" appears on the display.
- ⇨ Use the **<>** buttons (6) to choose between "DUAL ZONE ON" and "DUAL ZONE OFF".

When you have finished making your changes,

- ⇨ press the **MENU•OK** button (7) and then the **DIS•ESC** button (5) to exit the menu.

Specifications

Amplifier

Output power: 18 W RMS x 4 ch
 @ 14.4V
 @ 4 Ohm
 @ 1% THD

Tuner

Wavebands in the US:

FM: 87.5 - 107.9 MHz
 (200 kHz step)
 AM: 530 - 1710 kHz
 (10 kHz step)

Wavebands in Europe:

FM: 87.5 - 108 MHz
 (100 kHz step
 auto/50 kHz
 manual)
 AM: 531 - 1602 kHz
 (9 kHz step)

Wavebands in Thailand:

FM: 87.5 - 108 MHz
 (50 kHz step auto/
 25 kHz step
 manual)
 AM: 531 - 1602 kHz
 (9 kHz step)

Wavebands in South America:

FM: 87.5 - 107.9 MHz
 (100 kHz step auto/
 50 kHz step
 manual)
 AM: 530 - 1710 kHz
 (10 kHz step)

FM mono sensitivity:
 17 dbf

FM frequency response:
 35 - 16,000 Hz

DVD

Supported formats:
 DVD±R,
 DVD±RW,
 SVCD, VCD,
 JPEG.

Dolby Digital Coaxial™ output
 Video output
 PAL/NTSC support

CD

Supported formats:
 CD,
 CD-R,
 CD-RW.

Frequency response:
 20 - 20,000 Hz

Pre-amp out

4 channels: 2 V

Input sensitivity

AUX input: 2 V / 6 kΩ
 Tel./Navi input: 10 V / 1 kΩ

Subject to changes!

Please keep the filled-in radio pass in a safe place!

Prière de conserver soigneusement la carte d'autoradio remplie !

¡Favor guardar el documento del aparato debidamente llenado en un lugar seguro!

Por favor, guardar o cartão preenchido do aparelho num lugar seguro!

Country:	Phone:	Fax:	WWW:
Germany	(D) 0180-5000225	05121-49 4002	http://www.blaupunkt.com
Austria	(A) 01-610 39 0	01-610 39 391	
Belgium	(B) 02-525 5444	02-525 5263	
Denmark	(DK) 44-898 360	44-898 644	
Finland	(FIN) 09-435 991	09-435 99236	
France	(F) 01-4010 7007	01-4010 7320	
Great Britain	(GB) 01-89583 8880	01-89583 8394	
Greece	(GR) 210 94 27 337	210 94 12 711	
Ireland	(IRL) 01-46 66 700	01-46 66 706	
Italy	(I) 02-369 62331	02-369 62464	
Luxembourg	(L) 40 4078	40 2085	
Netherlands	(NL) 0800 400 1010	0800 400 1040	
Norway	(N) 66-817 000	66-817 157	
Portugal	(P) 2185 00144	2185 00165	
Spain	(E) 902 52 77 70	91 410 4078	
Sweden	(S) 08-7501850	08-7501810	
Switzerland	(CH) 01-8471644	01-8471650	
Czech. Rep.	(CZ) 02-6130 0446	02-6130 0514	
Hungary	(H) 76 511 803	76 511 809	
Poland	(PL) 0800-118922	022-8771260	
Turkey	(TR) 0212-335 06 71	0212-346 00 40	
USA	(USA) 800-2662528	708-6817188	
Brasil			
(Mercosur)	(BR) 0800 7045446	+55-19 3745 2773	
Malaysia			
(Asia Pacific)	(MAL) +604-6382 474	+604-6413 640	

● BLAUPUNKT

Gerätepass

Name: Long Beach DVD35

Typ: 7 645 680 310

Serien-Nr: **BP**

Blaupunkt GmbH, Robert-Bosch-Straße 200, D-31139 Hildesheim

